

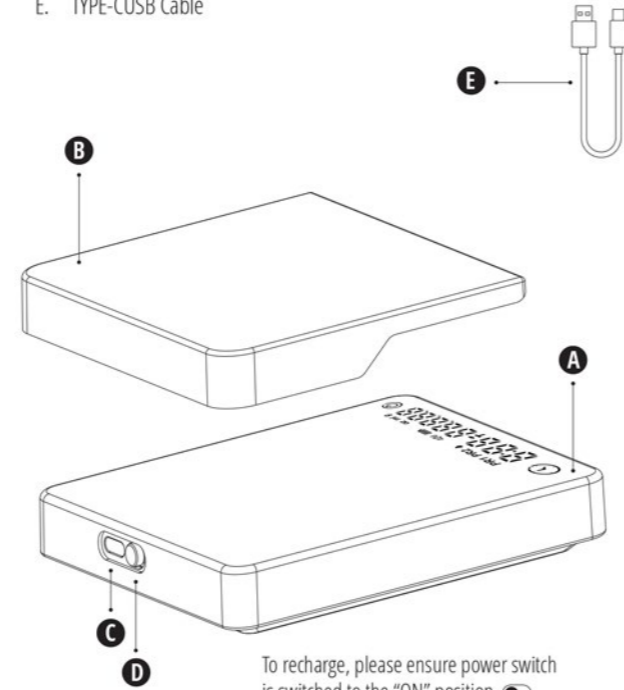



Need Help? Contact Flair
<https://flairespresso.com/contact>

PRODUCT COMPONENTS

- A. Coffee Scale
- B. Silicone Pad
- C. Power Switch: Toggle this button 
- D. TYPE-C Charging Port
- E. TYPE-CUSB Cable







To recharge, please ensure power switch is switched to the "ON" position . Do not use a quick charger.

WARNING

1. The scale is not waterproof. Do not wash. Keep the charging port dry.
2. The weighing capacity is 2,000g. Do not weigh objects over this maximum limit.
3. To maintain the battery lifespan, use a charging source with an output of five (5) volts and one (1) amp.
4. Do not use the scale while plugged in.
5. The scale must be used on a level surface.
6. The scale is not drop-proof and can be damaged. Handle with care.

PRODUCT SPECS

- Item: Flair Brew Scale
- Max. Capacity: 2,000g
- Division: 0.1g
- Weight Limit: 2,000g
- Material: ABS/Silicone
- Battery: built-in rechargeable 800mAh Lithium battery
- Charging Method: TYPE-C USB cable and 5V DC/1A adapter (self-provided)
- Charging Display:  flashes when charging,  is constantly on when fully charged
- Low Battery:  flashes when low battery. This continues until "L 
- Product Size: 95 x 100 x 19mm
- Units: g / oz / ml
- Timer Range: 9' 59"
- Display: LED Digit

Need Help? Contact Flair
<https://flairespresso.com/contact>



FLAIR BREW SCALE

Instruction Manual

FUNCTION INTRODUCTION

Press to start/stop timer
Press and hold to reset timer
Double press to change mode

Press and hold to turn on/off
Press to tare
Double press to change unit

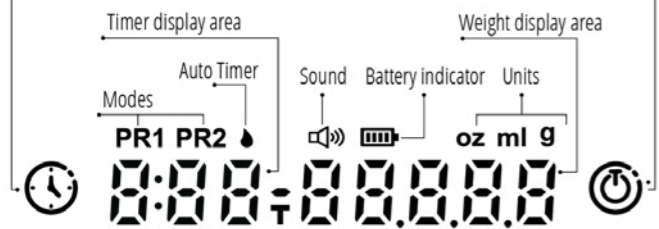

BASIC GETTING STARTED

Sound ON/OFF: press and hold "🕒" and "🔊" simultaneously for 1 sec

To reset timer and weight, double tap "🕒" button.

To tare weight, single tap "🔊" button.

To cycle through modes, double tap "🕒" button once then double tap a second time within 1 second to switch from PR1 to PR2.

To recharge, please ensure power switch is switched to the "ON" position Do not use a quick recharger.

VIDEO TUTORIAL



Scan the above with your phone's camera or visit: <https://flairespresso.com/flair-brew-scale-tutorials>

PR1 AUTO MODE

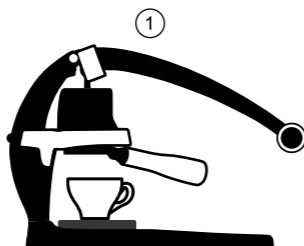

Place dose cup on scale, turn scale on and cycle to mode PR1. Add beans until desired dose. Remove dose cup and double tap "🕒" to reset. Put coffee scale onto the drip tray of your espresso maker. Place espresso cup on scale. Wait for "T" to illuminate and weight to zero out.

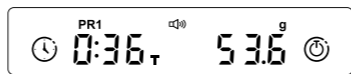
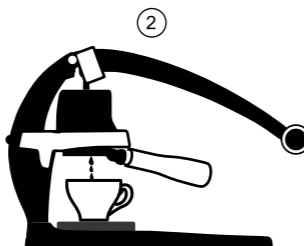

You are ready to brew. Timer and weighing function will commence as soon as first drops enter cup and will stop at end of pour.

* when cup is removed, 3-2-1 countdown begins to reset for back-to-back brewing

** if there are a couple seconds pause between first drips and subsequent flow, timer and weight function will end—use PR2 PRE-INFUSION MODE when incorporating pre-infusion

PR2 PRE-INFUSION MODE

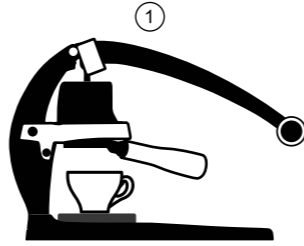

Place dose cup on scale. Turn scale on and cycle mode to PR2. Add beans until desired dose. Remove dose cup and place coffee scale onto the drip tray of your espresso maker. Place espresso cup on scale. Press and hold "🕒" button for 2 seconds, "☕" illuminates and auto-timer is switched on and weight zeroes out.

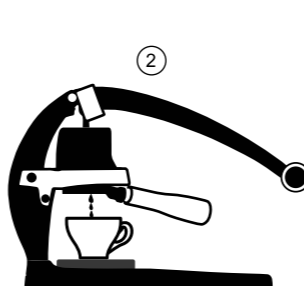

You are ready to brew. Timer and weighing function will commence as soon as first drops enter cup and will stop once cup is removed so long as time is greater or equal to :30s.

* When cup is removed, and time is greater than or equal to :30s, 3-2-1 countdown begins and scale resets for back-to-back brewing

** If time is less than :30s at end of pour, timer will continue even when cup is lifted.; take note of time and weight before lifting

PR2 MANUAL MODE

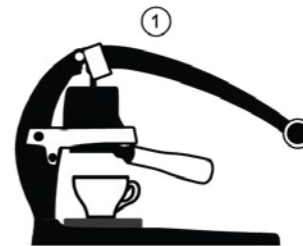

Place dose cup on scale, turn scale on and cycle to mode PR2. Add beans until desired dose. Remove dose cup and place coffee scale onto the drip tray of your espresso maker. Place espresso cup on scale. Press "🔊" to tare.

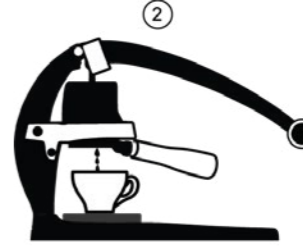

You are ready to brew. Press "🕒" to start time, weighing function will commence as soon as first drops enter cup.

* Timer continues to run even after end of pour or cup is removed; take note of time and weight at end of pour

** Timer can be stopped manually by pressing the "🕒" at any time